



LANDSCAPING

**MULCHERS FOR LANDSCAPING
AND MUNICIPAL APPLICATIONS**

INNOVATION MEETS TRADITION

The basis for sustainable success

Müthing is one of the leading suppliers of innovative mulching technology in Europe. Customers from 32 countries have associated the Müthing brand with quality products "Engineered in Germany" for many decades.

In 1898, the Müthing company was founded as a trader of scythes and spare parts in the Sauerland region. The first Müthing flail mower was developed, designed and sold as far back as 1998. Just two years later, the flail mowers were being exported to many different countries.

A family business with more than 120 years of tradition. Passion and experience, combined with a customer-focused approach, form the heart of the company - which is now being managed by the 4th generation of the family.

Customers, employees and system partners place a great deal of trust in the company due to its qualities of reliability and independence. This helps to ensure the long-term success of the company.



Founded in 1898 as a spare parts and scythe trader by Josef Müthing (framed picture), f.l.t.r.: Romanus Müthing, Dr. Michael Müthing



The assembly hall at the Soest location - Technology in perfection.



The development and sales centre with assembly halls of Müthing GmbH & Co KG Soest.



Satisfied customers are the goal of our work.

For many years, Müthing has been a byword for outstanding work results thanks to its pioneering Vario flail mowers.

In cooperation with technology partners from the scientific and research sectors, as well as customers from many countries, the company is continuously developing new products that combine agriculture and sustainability.

Constant innovations are the key to designing professional and contemporary landscaping technology combined with sustainable protection of insects to preserve the overall ecological environment. Through constant dialogue with users, the family company is able to produce flail mowers that meet the high demands of daily use and fulfil practical requirements.



CONTENTS

Why mulching?	4-5
Müthing flail mowers in detail	6-15
Our product range (brief overview)	16-19
Flail mower model series	20-51
Service	52-53
Technical data	54-55

WHY YOU SHOULD MULCH



MULCHING: SUSTAINABLY EFFICIENT GREEN SPACE CARE

It is the result of the work that counts, both for the public in their role as the end customer and for the local authorities, service providers and facility managers that do the work. It is important to provide attractive green spaces using natural means, while also observing all relevant safety aspects. The following points are important to consider:

- Not using pesticides where children play or pets can be found
- Environmentally compatible care methods
- Ongoing care to retain the usual visual quality
- Prompt completion of work at low cost

One aspect of efficiently achieving these aims involves helping nature with its natural processes.

- Finely mulched plant material decomposes quickly, allowing a well-maintained visual appearance to be restored within a very short period of time.
- Mulch that has decomposed quickly is an excellent nutrient and is also distributed uniformly during the mulching

process. This completely removes the need for additional fertilising.

- If they are mulched before they run into seed, grasses and unwanted plant growth on non-intensively maintained side strips are reliably reduced.
- The activated soil biology makes the ground more resistant to traffic and dry periods.

Non-intensively landscaped areas require sturdy mulchers that can manage large quantities of plant material, while intensively landscaped areas require an excellent cutting pattern.

With Mülching mulchers, you can achieve optimal results in all of your particular applications. Our flail mowers can take care of your exact requirements, whether you are aiming to achieve a rougher but economical result on non-intensively maintained land or need to efficiently achieve a perfect result on intensively maintained spaces such as football pitches or parks.

MULCHING FOR LANDSCAPING APPLICATIONS



SPORTS GROUNDS AND PLAYING FIELDS require optimal and visually perfect surfaces. Müthing flail mowers shred the plant material particularly intensively, resulting in healthy plants and a rich green colour thanks to the decomposition of the quickly and uniformly distributed plant material, which acts as a nutrient. The stimulation of the soil biology improves playability even in heavy rain and ensures the best possible resistance to dry conditions.



GOLF COURSES have their own special requirements. Greens are maintained on a daily basis, while fairways and the semi-rough need to retain their top-quality appearance and playability but with significantly reduced effort and lower costs. Thanks to their intensive shredding and the resulting faster decomposition, Müthing mulchers provide the exact surface you are aiming to achieve and can also be used for non-intensive maintenance of the rough.



PARK FACILITIES are characterised by flowering meadows and intensively maintained sunbathing lawns. Our outstanding shredding of the plant material restores the well-maintained appearance of the green spaces very quickly and ensures that unwanted plants are reduced, while also retaining the desired flowering meadows.



INDUSTRIAL AREAS/CONSTRUCTION SITES need to provide a well-maintained impression for new investors and existing neighbours but at low cost. Non-intensive maintenance in the form of mulching once or twice a year will ensure a rich green colour of the desired areas and will also reduce hiding places for rodent pests.



FALLOW LAND AND MEADOWLAND is maintained non-intensively, which results in large quantities of plant growth. Nevertheless, this large throughput of plant mass still has to be shredded intensively in order to ensure a fast and reliable decomposition process. This prevents the formation of fungi and rotting odours and the land regains an attractive visual appearance quickly.



ROADSIDE GREENERY/SIDE STRIPS are about achieving a high level of road safety combined with an attractive appearance on motorways, roads and tracks. This means large intervals and fast greening processes combined with intensive shredding of the mulch to minimise the risk of fire in dry periods.



DRAINAGE DITCHES/RESERVOIRS must be protected by fast decomposition of the green waste before it can cause clogging or float away. The steep terrain alongside passageways and spillways presents a particular challenge, which Müthing mulchers master impressively thanks to their low centre of gravity.

MÜTHING FLAIL MOWER IN DETAIL

WHY MÜTHING FLAIL MOWERS CAN DO MORE

The sum of all details come together to make a Müthing flail mower perfect for use on your land.



1. Highly tempered spring steel flaps with swing protection provide safety for you, your colleagues and your tractor. They hold back foreign objects reliably and reduce damage.



2. The Technical Inspection Association (TÜV-Nord) stone projection test is your assurance that we have done everything possible to ensure the safety of you and other people within the operating area of the flail mower. The safety clearances are thus reduced to 2m alongside the machine and 8m in front of and behind the machine.



3. Fine-grain steel is the material that is used to make Müthing flail mowers. Its outstanding wear-related properties and high strength allow our machines to be lighter. This reduces the balast on the tractor and on the ground.



4. The shark fin has a self-cleaning and replaceable design. It ensures uniform shredding of all of the material. Long material is fed through the rotor in a second step in the crop flow, whereas material that is already shredded passes through. The result is homogenous mulched material.



5. The mechanical side shift allows the flail mower to be adjusted to the tractor track or offset to the side. The adjustment can be made manually for a constant working position without any further requirements on the tractor.



6. Hydraulic side shift* makes it possible to work around posts and trees or operate the flail mower outside of the tractor track. On the edges of tracks or embankments, the tractor remains on a passable surface while the flail mower can operate alongside it.



7. The freewheel in the gear box/hydraulic motor protects the rotor from abrupt braking and the tractor from excessive torque when shutting off the PTO shaft. Incorrect operation of the drive system is no longer possible.

KEY FEATURES THAT MAKE A BIG DIFFERENCE

Based on an example of MU-E 160 Vario:

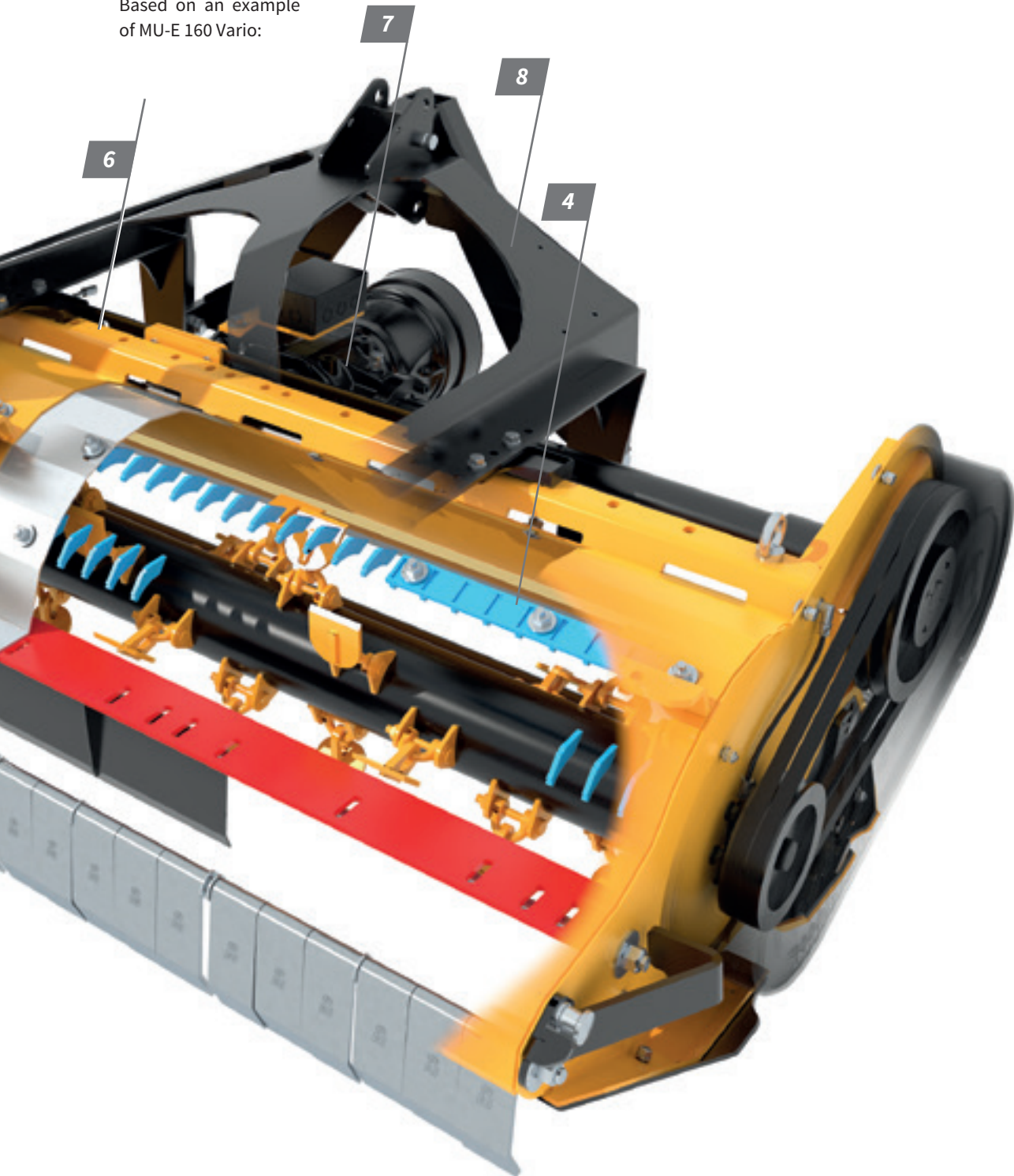

8. Front-Rear headstock* allows mounting in front of or behind the tractor, without any additional complexity. Decide whether you want to mount at the front or at the rear depending on the task and tractor.

(Optional in some cases*)



9. Automatic belt tensioning keeps the drive belt under tension, whether it is cold or warm and whether the belt is new or already run in. Once adjusted, the tension is automatically maintained at the set level.

MÜTHING FLAIL MOWER IN DETAIL

Based on an example of MU-E 160 Vario:

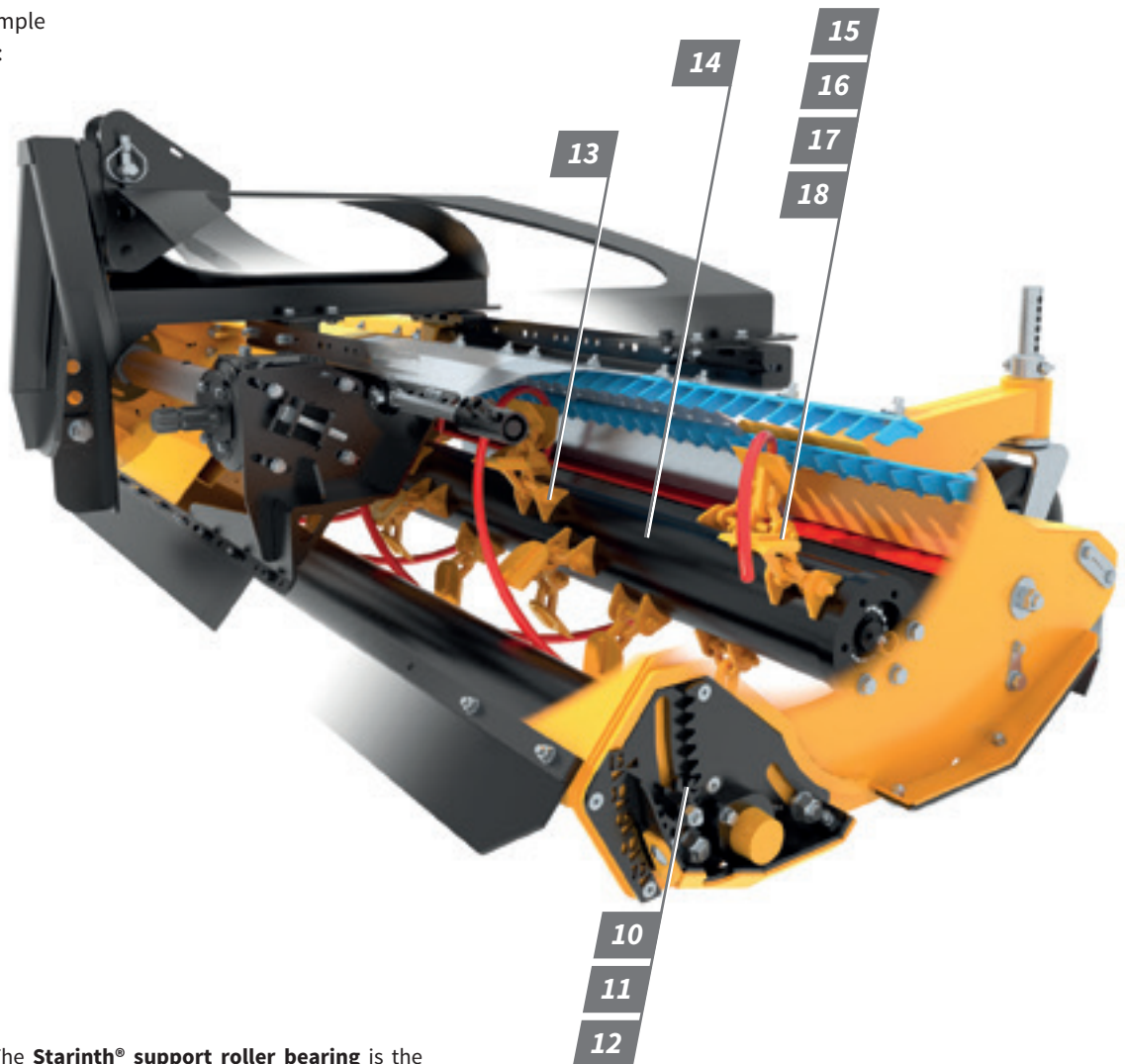

10. The **Starinth® support roller bearing** is the heavy-duty support roller bearing of Müthing. With lifetime lubrication, the bearing is protected by a labyrinth seal and housed in a unit which is mounted in a star-shaped contour to prevent twisting. Impacts on the bearing are minimised by the star-shaped contour and the service life of the bearing is thus optimised (available as of the MU-L model series).



11. The **vertically adjustable support roller/support wheels*** make it possible to adjust the mower to different working depths. Residues that are mulched to a minimum can be achieved just as easily as rich green turf.



12. The **support roller with infinitely variable vertical adjustment** allows you to set an exact cutting height on any terrain. The vertically guiding support roller produces a uniform mowing pattern with directional mowing stripes and the best possible mulch distribution - adjusting it is child's play.



13. The **tangential tool holders** lift the rotor over obstacles and thus protect against imbalance. The connection to the rotor is improved by the longer weld seam, which prevents the tool holders from breaking off.



14. The **twin-spiral rotor** ensures uniform operation of the rotor. This reduces fuel consumption, while also reducing the load on the drive line at the same time. This extends the service life of the gear boxes and PTO shafts. The internal bearing and wide bearing shells provide protection against foreign objects and perform an anti-wrapping function.

KEY FEATURES THAT MAKE A BIG DIFFERENCE

NEW



15. Carbide M-shackle flails are an efficient tool for any landscaping application. The straight blade made of DuraX steel ensures a uniformly even cutting pattern as well as significantly improved wear resistance. The tool features increased cutting momentum and uniform weight distribution. The shackles give the flails the required clearance to avoid foreign objects.

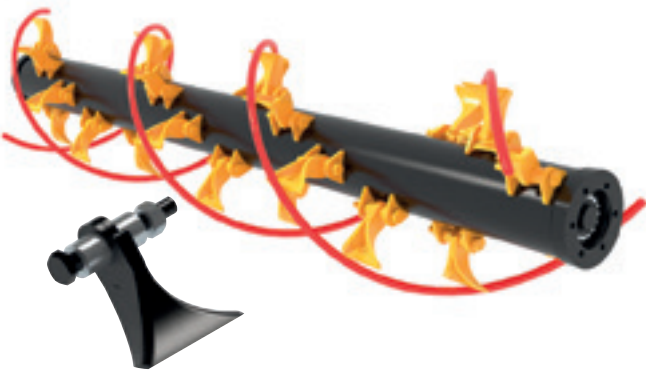

16. M-scoop blades* are used for lighter materials in landscaping applications, to ensure a uniform cutting pattern even on surfaces with high appearance-related requirements. Ideal material delivery performance thanks to the aerodynamic scoop shape.



WITH NEW ALLOY!



17. The **M-DuraX hammer flail** with high-strength boron-alloyed and tempered steel ensures high wear resistance with a new optimised alloy. This enables up to 50% longer use. The optimal ergonomic properties produce a perfect mulching result. The M-DuraX hammer flail is smoother running for better self-sharpening and lower diesel consumption. Whether you are looking to make a clean cut through grass or shred some shrubbery, the hammer flail is the universal tool for all conditions.

GOOD TO KNOW:

The M-DuraX hammer flail (17.) and M-shackle flail (18.) are available as of the MU-H model series.

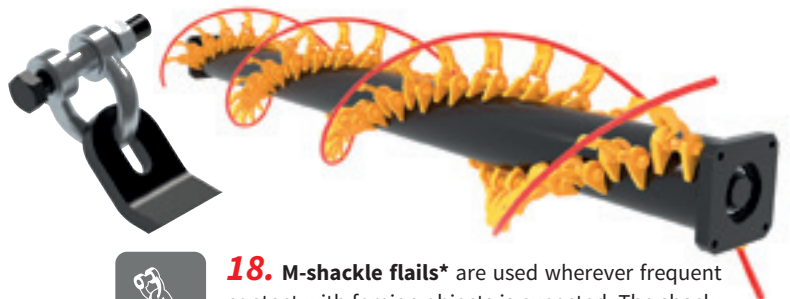

18. M-shackle flails* are used wherever frequent contact with foreign objects is expected. The shackles give the flails the required clearance to avoid foreign objects. This protects against damage and allows trouble-free operation.

(*Optional in some cases)

MÜTHING FLAIL MOWER IN DETAIL

THE MU-VARIO® SYSTEM FROM MÜTHING

For maximum working convenience and flexibility



22. The **MU-Vario® system** allows you to adjust the flail mower to your conditions thanks to its optimal intake and housing form, variable PTO shaft speeds, an infinitely variable Vario cutting bar and a swivelling short-cut flap.

1. The **adjustable cutting bar** allows infinitely variable adjustment of the shredding rate to the respective requirement.

- Optimal mulching result even in wet conditions, on tramlines, with low plant mass content or plant mass that is difficult to shred such as leaves or branches.
- Compacted crop residues can be reached due to the strong suction effect.
- You can select the optimal shredding configuration for your individual requirements, whether you are looking to achieve fast decomposition or a protective surface covering.

Higher vehicle speeds and higher surface outputs with constant quality are possible thanks to the infinitely variable shredding rate.

2. Shark fin:

- Uniform shredding of all particles and homogenous mulch.
- Long material is fed to the rotor in a second step, whereas material that is already shredded passes through.
- Self-cleaning and replaceable.

3. The **swivelling short-cut flap** turns the flail mower into a piece of equipment that can be used all year round. The short-cut flap makes the flail mower versatile and suitable for the widest possible range of conditions and requirements (available for the MU-E Vario and MU-E/F Vario and as a short-cut angle for the MU-Collect Vario).

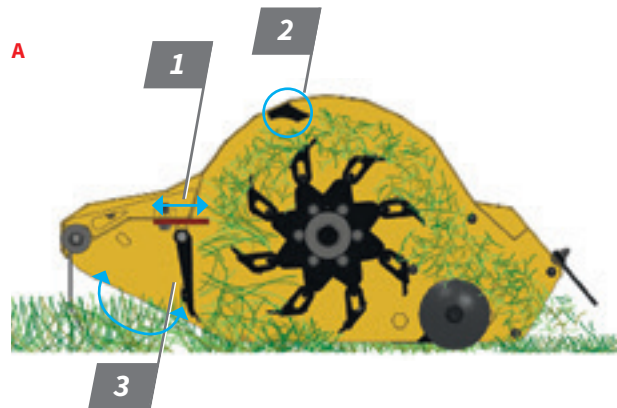

A Short-cut flap swivelled downwards:

- Extremely strong suction effect to stand up compacted grass and produce a top-class cutting pattern.
- Ideal for use on demanding surfaces and with short cutting lengths.
- Perfect for football pitches, sports grounds and golf courses.
- The fine mulch is deposited uniformly for fast decomposition.
- Heap formation is avoided to ensure uniform nutrient recirculation and a clean appearance.

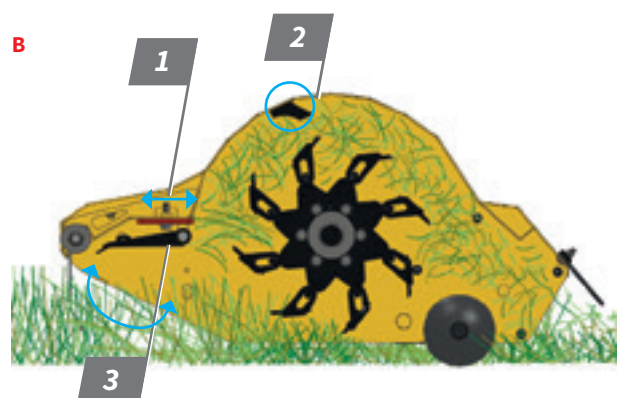

B Short-cut flap swivelled upwards:

- High throughput and lower power requirements for taller crops and areas with a lot of plant mass.
- Ideal for non-intensive groundcare and areas of tall growth.
- Reduced suction effect and a larger inlet area for fast working and reduced shredding.
- Uniform mulch discharge to cover the surface of the ground.

KEY FEATURES THAT MAKE A BIG DIFFERENCE



Versatile use - The correct processing for every crop

Individual settings for different situations and materials such as grass, reeds, bushes, leaves and branches.

Flexible shredding rate adjustment

The shredding rate of the mulch can be variably adjusted thanks to the adjustable cutting bar.

OUR VIDEO TIP:

PROFESSIONAL LAWN MAINTENANCE



We are all about versatility.

Mühling flail mowers are suitable for mulching embankments and track edges and are also at home in the rough. See for yourself - Just scan the QR code!

MÜTHING FLAIL MOWER IN DETAIL



23. The **mechanical collision protection device (side arm)** prevents damage in the event of a collision - without compromise. You do not have to make any more adjustments, the collision protection device is adapted to the flail mower. You cannot accidentally adjust it incorrectly or forget to use it, the collision protection device is always in operation. A Müthing patent.

(*Optional in some cases)

CONVERSATIONS FROM THE FIELD - WHERE THE EXPERTS ARE FOUND



Enthusiastic testimonials from our customers

The satisfaction of our Mühling customers is close to our hearts. Here you can read more about their successes in using our flail mowers.

"THE MU-COLLECT QUICKLY IMPRESSED ME IN PRACTICAL USE - IT PERFORMS TWO WORK STEPS IN ONE AND PROVIDES GOOD SURFACE OUTPUT TO BOOT"

Jürgen Kutscher, Garten- und Landschaftsbau Kutscher, Paderborn-Salzotten

I became aware of the MU-Collect during a demonstration on a neighbouring golf course. A short time later, I was able to test the machine extensively at my own business.

My initial scepticism about whether the MU-Collect collects the material cleanly during scarifying was unfounded: Even under adverse conditions, the implement delivers a great result. My requirements for the mulcher were very stringent as it is mainly used on the well-manicured football turf at SC Paderborn.

I need the surface to be perfectly scarified and all material to be collected!

These requirements have been fully met. I have a high surface output and can do two work steps at the same time with only one worker.

So I save time and money with a first-class work result!

That's what impressed me! In addition, we can use the MU-Collect all year round. When I'm not working on the sports grounds, I use the implement for classic mulching work on larger commercial areas - even when there is a lot of growth or for collecting leaves in autumn. This means that I achieve a high utilisation rate with the mulcher throughout the year.

THROWN-OBJECT TEST CERTIFIED BY TECHNICAL INSPECTION ASSOCIATION



STAY ONE STEP AHEAD WITH CERTIFIED SAFETY!

- Europe's agricultural machinery manufacturers have to produce their machines in accordance with CE machinery directives.
- Applying the CE marking is a self-declaration of compliance with the CE directives.

- One of these CE machinery directives is entitled: "Thrown-object test and acceptance criteria for flail mulchers as per ISO/WD 17101-2".
- We went one step further and commissioned an independent, accredited institute - TÜV Nord - to assess and certify our compliance with this machinery directive.

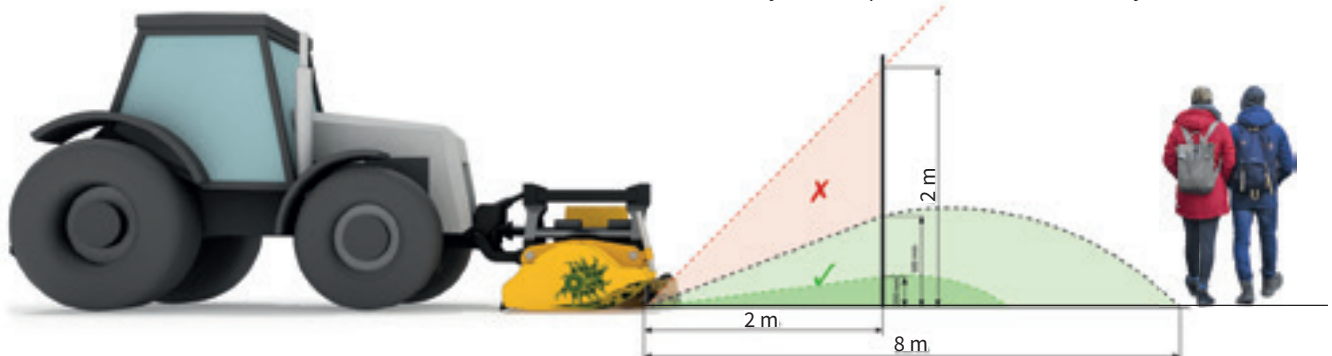

YOUR ADVANTAGE: MAXIMUM SAFETY AND WORRY-FREE OPERATION

With observation of the safety clearances of 8 metres towards the front and rear and 2 metres towards the right and left.



MU-SOFA® WEIGHT TRANSFER SYSTEM AS ACCESSORY

THE ADJUSTABLE HYDROPNEUMATIC MU-SOFA® WEIGHT TRANSFER SYSTEM FOR ALL FRONT-MOUNTED IMPLEMENTS:

- Noticeably improves the steerability and traction of the tractor with front-mounted implements.
- Offers significantly improved comfort for the driver during transport and while working.
- Improves the depth guidance and ground following of front-mounted implements and thus the operation of the equipment.
- Makes it easier to maintain a uniform distance from the ground and prevents damage due to heavy contact with the ground.
- Features simple adjustability of the weight transfer function to various weight and working requirements.
- Protects the implements from wear and absorbs vibrations during transport and while working.
- Removes the need for additional implement accessories such as front wheels and spring-based weight transfer systems.

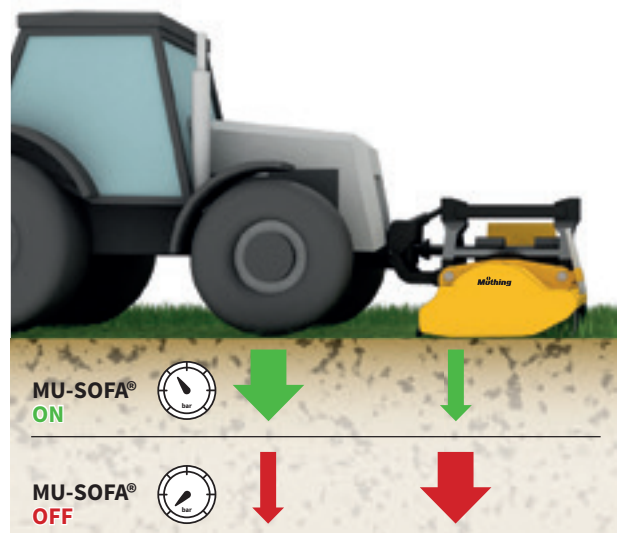

MU-SOFA® tractor mounting

Mounted directly on the tractor, the contact pressure can be quickly adjusted when switching between front-mounted implements such as flail mowers, mowers or snowploughs. The MU-SOFA® can be easily integrated into all of the hydraulic circuits commonly used in front hydraulic systems (installation time approx. 4 hours).



MU-SOFA® implement mounting

With MU-SOFA® mobile, permanent attachment to the respective implement is possible. To do so, an additional T-piece is connected to the hydraulic feed line of the tractor.

OUR PRODUCT RANGE

MU STANDS FOR MULCHING WITH MÜTHING

The widest range of mulchers for use in green space care/landscaping. Designed to take care of your specific shredding task. A top-class mulching result is something that all Müthing flail mowers have in common. You can depend on it!



Page 22-23

MU-B

Front mounting

- Mulcher for single-axle tractors
- Compatible with Aebi, Köppl, Rapid, Reform and Bucher
- Compact design ensures easy handling on carrier vehicle
- Suitable for driving powers from 15 to 24 hp
- Working width: 0.8 m / 1.00 m / 1.20 m / 1.40 m



Page 24-25

MU-C

Front or rear mounting

- Lightweight mulcher for smaller compact tractors and carrier vehicles
- Compact, lightweight but sturdy design with high throughput
- Front mounting on all common compact tractors and carrier vehicles thanks to low-mounted gear box
- Suitable for driving powers from 15 to 35 hp
- Working width: 0.80 m (rear mounting only) / 1.00 m / 1.20 m / 1.40 m / 1.60 m



Page 26-27

MU-C Hydro

Front mounting

- Suitable for hydraulic powers from 35 to 55 l/min
- Working width: 1.20 m / 1.40 m / 1.60 m

MU-C/S

Rear mounting

- Entry-level side mulcher with fixed side mounting for smaller municipal tractors
- Compact design allows it to also be used on lighter tractors
- Simple operation
- Suitable for driving powers from 20 to 35 hp
- Working width: 1.00 m / 1.20 m

*Some model series can be converted from 540 rpm to 1000 rpm, which makes higher driving powers permissible. In these cases you will see two horsepower values. Some illustrations show optional equipment. The right to technical revision is reserved. Illustrations may not show the latest production version.

THE SHREDDING EXPERTS, A MATCH FOR ANY CHALLENGE



Page 28-29

MU-FM

Front mounting

- Professional mulcher for a very wide variety of carrier vehicles
- Optimal mounting with specific support arms or coupling triangle
- Sturdy design for maximum throughput and a long service life
- Suitable for driving powers from 20 to 40 hp
- Working width: 1.20 m / 1.40 m / 1.60 m

MU-FM Hydro

Front mounting

- Suitable for hydraulic outputs from 35 to 70 l/min
- Working width: 1.20 m / 1.40 m / 1.60 m

MU-Ecotop

Front attachment

- Landscaping mower for the sustainable protection of insects and small organisms.
- Protects reptiles and small organisms on the ground due to a reduced suction effect of the Y-blades at a working height of up to 11 cm
- Organisms that are active above the ground are scared away by the forward-mounted insect rescuer
- Suitable for driving powers from 20 to 40 hp
- Working width: 1.40 m / 1.60 m

MU-Collect Vario

Front attachment

- Professional flail mower with mulching, scarifying and collecting function
- Suitable for driving powers from 20 to 40 hp
- Working width: 1.40 m / 1.60 m

MU-Collect Hydro Vario

Front attachment

- Suitable for hydraulic outputs from 40 to 70 l/min
- Working width: 1.40 m / 1.60 m

MU-FM/S

Rear mounting

- Professional rear/side mulcher for small compact tractors
- For maintaining ditches, embankments and track edges
- Patented automatic collision protection device
- Suitable for driving powers from 30 to 45 hp
- Working width: 1.20 m / 1.40 m / 1.60 m

NEW



Page 30-31



Page 32-33



Page 34-35

OUR PRODUCT RANGE

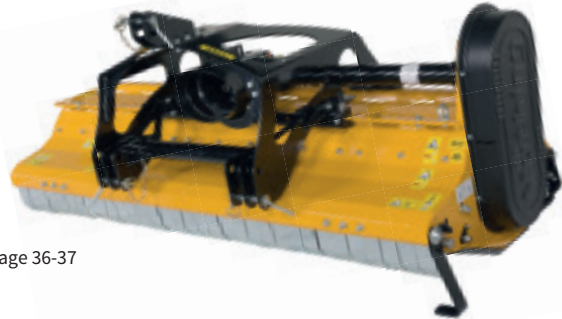

Page 36-37

MU-E Vario

Front or rear mounting

- Versatile professional flail mower suitable both for fine cutting and surfaces with heavy growth
- Side shift function, stepless cutting height adjustment and MU-Vario® system
- Suitable for driving powers from 25 to 50/60 hp*
- Working width: 1.20 m / 1.40 m / 1.60 m / 1.80 m / 2.00 m



Page 38-39

MU-E Hydro Vario + MU-Connect 200

Front attachment

- Patented implement holder for flail mowers of the MU-E Hydro Vario series
- Various holders are available for wheel and yard loaders of different manufacturers
- For vehicles with up to 90 l/min
- Suitable for hydraulic powers from 50 to 90 l/min
- Working width: 1.40 m / 1.60 m / 1.80 m / 2.00 m



Page 40-41

MU-E/F Trail

Rear attachment

- Drawn large-area flail mower
- Maximum working width with a manageable transport width of 2.5 m and an overall height of 3 m
- Suitable for driving powers from 60 to 180 hp
- Working width: 3.60 m / 4.60 m / 5.60 m



Page 42-43

MU-E/S

Front or rear attachment

- Powerful side embankment flail mower for compact tractors and carrier vehicles
- Hydraulic side shift
- Suitable for driving powers from 30 to 60 hp
- Working width: 1.20 m / 1.40 m / 1.60 m

*Some model series can be converted from 540 rpm to 1000 rpm, which makes higher driving powers permissible. In these cases you will see two horsepower values. Some illustrations show optional equipment. The right to technical revision is reserved. Illustrations may not show the latest production version.

THE SHREDDING EXPERTS, A MATCH FOR ANY CHALLENGE



Page 44-45

MU-H Vario

Front and/or rear mounting

- Sturdy mulcher for daily use on medium-sized tractors and carrier vehicles
- Universally applicable, from parks to roadside greenery
- Hydraulic side shift and MU-Vario® System
- Suitable for driving powers from 35 to 75/90 hp*
- Working width: 1.20 m/ 1.40 m/ 1.50 m/ 1.60 m/ 1.80 m/ 2.00 m/ 2.20 m



Page 46-47

MU-H/S Vario

Rear attachment

- Medium-duty rear/side mulcher for mounting on medium-sized tractors and carrier vehicles
- Particularly suitable for the maintenance of side strips, embankments and ditches
- Versatility thanks to large swivel and adjustment range
- Patented automatic collision protection device
- Suitable for driving powers from 55 to 90 hp
- Working width: 1.40 m/ 1.60 m/ 1.80 m/ 2.00 m



Page 48-49

MU-L Vario

Front and/or rear attachment

- Universal mulcher with large working width for medium-sized to large tractors and carrier vehicles
- For continuous use in coarse material and under difficult landscaping conditions
- MU-Vario® System with swivelling support roller (optional)
- Suitable for driving powers from 45 to 100/130 hp*
- Working width: 1.80 m/ 2.00 m/ 2.20 m/ 2.50 m/ 2.80 m



Page 50-51

MU-L/S Vario

Rear attachment

- Professional rear/side mulcher for the toughest applications
- Large working width, also suitable for medium-sized tractors as side mulcher
- Very large swivel and adjustment range, with patented collision protection device
- Suitable for driving powers from 75 to 130 hp
- Working width: 2.00 m/ 2.20 m/ 2.50 m

OUR PRODUCT RANGE



PROFESSIONAL SHREDDING ON GREEN SPACES/ FOR LANDSCAPING APPLICATIONS

Optimal mulching with Müthing

Thanks to users like you, who we maintain an ongoing dialogue with, we are able to build flail mowers that meet both the tough demands of day-to-day use and your requirements. As a family-run company located in Soest in North Rhine-Westphalia, we design and develop pioneering mulchers which are a pleasure to work with.

Agriculture, landscaping or special crops - operating reliability and the best mulching result regardless of where and how you want to work. Every Müthing flail mower is a specialist when it comes to first-class mulching quality and shredding. You can rely on our flail mowers because ultimately we build machines for you and your needs.

EXPERIENCE MÜTHING FLAIL MOWERS LIVE - PUT US TO THE TEST



NEED TO SEE IT FOR YOURSELF? NO PROBLEM!

Would you like to experience our Müthing flail mowers live in action? It will be our pleasure! Put us to the test and arrange a demonstration appointment: info@muething.com

MU-B

SMALL, HANDY AND SERIOUSLY POWERFUL

- Compatibility with quick coupling adapters for Aebi, Köppl, Rapid, Reform and Bucher
- A proven tool for any task: The carbide M-shackle flail
- Full power transmission stops when it has to: gear box with integrated overrun brake
- Continuously under tension and low-maintenance: the automatic belt tensioning system
- Hardox™ wear runners as standard



Driving power in hp:



Working width in metres:

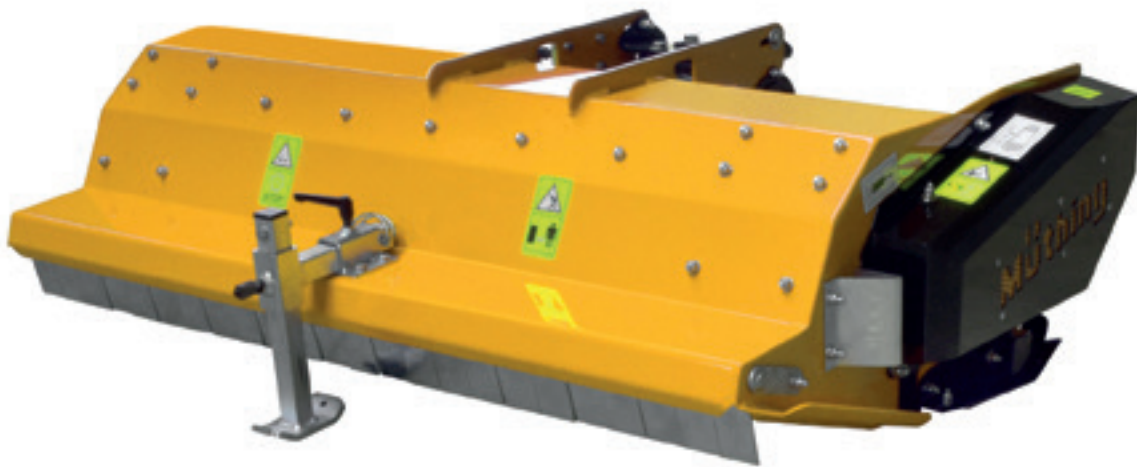

MÜTHING WORK QUALITY WITH A SINGLE-AXLE TRACTOR



AEBI (CC 56, CC 66 and TC 07)



KÖPPL (Gekko)



RAPID (EURO 4 and Orbito)



Reform (M 14) and Bucher



Trouble-free and low-maintenance operation due to the efficient design of the automatic belt tensing system.



The MU-B impresses with its sturdy, compact and low design – a crucial advantage when working with a single-axle tractor.



Thrown-object test certified by TÜV Nord certification body: Maximum safety and worry-free operation.



Sturdy, screw-type carbide M-shackle flails and the full-length trailing support roller ensure a perfect mowing result. Smooth-running double Y-blades are available optionally.

Technical Specifications

	MU-B	80	100	120	140
Working width (cm)		80	100	120	140
Total width (cm)		97	117	137	157
Weight (kg)		120	137	154	171
Number of carbide M-shackle flails		12	16	20	24

MU-C | MU-C Hydro

LIGHTWEIGHT BUT POWERFUL

- Optimal work results from just 15 HP
- A proven tool for any task, the carbide M-shackle flail
- From support arms to quick coupling triangles, the correct type of mount is available for your vehicle
- MU-C Hydro, hydraulically powered for vehicles without PTO shaft



Driving power in hp:



Hydraulic motor l/min:



Working width in metres:



ENTRY-LEVEL LANDSCAPING



The MU-C for front mounting: Low coupling points and a low-mounted gear box (input speed of 1000 or 2000 rpm).

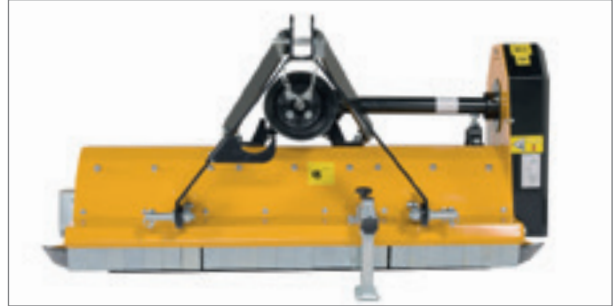

The MU-C for rear mounting: Cat. 1 headstock and an overhead gear box (input speed of 540 or 1000 rpm).



Hydraulic drive of the MU-C Hydro for front mounting on special-purpose vehicles.



Finally graduated, adjustable support roller for depth guidance.



Easily accessible bearing points for quick maintenance.



Sturdy support wheels for front attachment facilitate handling and improve ground following (optional). They are vertically adjustable and swivel through 360°.

Technical Specifications

MU-C MU-C Hydro	80 --	100 --	120	140	160
Working width (cm)	80 --	100 --	120	140	160
Total width (cm)	97 --	124 --	144	164	184
Tractor HP (max.), front/rear	--/35 --	35/35 --	35/35 --	35/35 --	35/35 --
Weight (kg), front/rear	--/154 --	145/169 --	151/185 138	159/200 146	175/215 154
Number of carbide M-shackle flails	12 --	16 --	20	24	28
Oil volume, l/min	--	--	-- 35	-- 40	-- 45

MU-C/S

TOP-QUALITY SIDE FLAIL MOWER FOR SMALL MUNICIPAL TRACTORS

- Suitable for small municipal tractors as of 0.8 m track width
- A proven tool for any task, the carbide M-shackle flail
- Very simple handling with just one single-acting control device
- Side offset from tractor centre of 58 cm provides additional stability



Driving power in hp:

20 35

0 hp

140 hp

Working width in metres:

1.0 | 1.2

0.8 m

3.0 m



LANDSCAPING ALSO ON EMBANKMENTS AND DITCHES



Short design for a centre of gravity close to the tractor.



Easily accessible transport safety device thanks to shutoff valve.



V-belt tension is always visible: V-belt protection with inspection opening.



Hardox™ wear runners as standard for long service life.



Easily accessible bearing points for quick maintenance.

Technical Specifications

	MU-C/S	100	120
Working width (cm)		100	120
Max. tractor hp		35	35
Weight (kg)		208	225
Number of carbide M-shackle flails		16	20



	100	120
A	58	58
B	121	121
C	158	178
E	90	90
F	45	45



Working/adjustment ranges (cm)

- A Side mounting to right approx.
- B Transport length to rear approx.
- C Total width to right approx.

Working ranges (°)

- E Angular range upwards
- F Angular range downwards

MU-FM | MU-FM Hydro

PROFESSIONAL MULCHING TECHNOLOGY FOR LARGE MOWERS

- Large mower, loader or carrier vehicle - the MU-FM is the right fit
- A proven tool for any task, the carbide M-shackle flail
- Cutting height adjustment with steplessly adjustable support roller
- A quick cut: The high blade speed of 55 m/s ensures a perfect cutting pattern
- MU-FM Hydro, hydraulically powered for vehicles without PTO shaft
- Forward-mounted insect rescuer optional



Driving power in hp:



Hydraulic motor l/min:

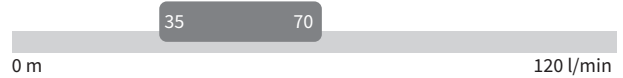

Working width in metres:



WHEN THE RESULT COUNTS

A selection of the adapters available for the MU-FM.



Example - Kubota:
2021 Series - Model
F-251, F-391, 2014 Series
- Model F2890, F3090,
F3890, 2006 Series -
Model F2880, F3680,
F2560, F3060, F3560

Example - John Deere:
935, 1145, 1435, 1445,
1545, 1565, 1550, 1570,
1575, 1580, 1585

Example - Iseki:
SF 224, 235, 300,
303, 310, 330, 333,
370, 438, 450, 544,
551

Example - Shibaura: CM
284, 314, 364, 374

Example - Headstock
with Cat. 0 or Cat. 1 N
coupling triangle

Example - Toro GM 360:
Mounting triangle with
Quick-
Attach-System

**Other models on re-
quest!**



The loader mount for the MU-FM Hydro with sturdy design. Adapters for Avant/ EURO 3/ Schäffer KR and SWH/ Weidemann and Cat. 0 and Cat 1 N coupling triangle. Other models on request.

Maximum degree of freedom for ground following.



Front support wheels installed as standard facilitate handling and improve ground following. They are vertically adjustable, swivel through 360° and are available optionally in the form of rear support wheels instead of the support roller.



Hardox™ wear runners for long service life.



The forward-mounted insect rescuer scares away small organisms such as flying insects, dragonflies and bees that are sitting on raised blades of grass.

Technical Specifications

MU-FM MU-FM Hydro	120	140	160
Working width (cm)	120	140	160
Total width (cm)	145	165	185
Max. tractor HP 2200 rpm	40 --	40 --	40 --
Weight (kg)	206 201	229 217	252 232
Number of carbide M-shackle flails	20	24	28
Oil volume, l/min	-- 35-70	-- 45-70	-- 45-70



V-belt tension is always visible:
V-belt protection with
inspection opening.

MU-ÖKOTOP

A LANDSCAPING MOWER TO PROTECT THE OVERALL ECOSYSTEM

- Protects wild animals, reptiles and small organisms on the ground due to a reduced suction effect of the Y-blades at a working height of up to 11 cm
- Preserves soil life through the use of support wheels instead of a support roller
- Organisms that are active above the ground such as flying insects, dragonflies and bees are scared away by the forward-mounted insect rescuer
- Promotes humus formation and prevents erosion as organic matter remains on the surface
- CO₂ binding due to high humus content
- Inhibits evaporation and helps to retain moisture, positively affects organisms in the soil
- Rapid decomposition and liberation of nutrients through optimal preparation of the plant material
- Well-maintained surfaces with maximum protection for the overall local ecosystem



Driving power in hp:



Working width in metres:



NEW



SUSTAINABLE PROTECTION OF THE OVERALL ECOSYSTEM



Vertically adjustable support wheels, 360-degree swivelling



Forward-mounted insect rescuer as standard.



With mounting parts for Kubota, John Deere, Iseki, Shibaura and coupling triangle. Other models on request.



Front and rear support wheels are used deliberately instead of a support roller to protect the soil life, as they do not compact the soil over a wide area.

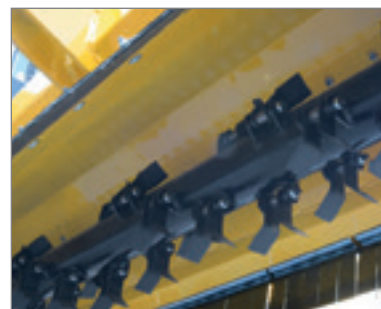

There is a lower suction effect thanks to the special Y-blades installed on the rotor and a variably adjustable working height of up to approx. 11 cm, meaning that reptiles and small organisms remain on the ground and do not come into contact with the Y-blades.

Technical Specifications

MU-Ecotop	140	160
Working width (cm)	140	160
Total width (cm)	165	185
Max. tractor HP 2200 rpm	40	40
Weight (kg)	236	283
Number of Y-blades	24	28

MU-COLLECT Vario | MU-COLLECT Vario Hydro

PROFESSIONAL MULCHING TECHNOLOGY AND COMPLETELY TIDY SURFACES

- Everything is possible with the MU-Collect Vario: An exact mulching result, a perfectly scarified surface and cleanly collected mulch.
- Thanks to the excellent suction effect of the MU-Collect, leaves, acorns, chestnuts and small branches are shredded effortlessly and collected cleanly.
- Whether you are operating a large mower or compact tractor, the MU-Collect is also able to discharge to the centre or to the right, and features mechanical or hydraulic drive
- A feeder auger brings the plant material together to ensure reliable operation even under high throughput levels
- The available MU-Vario® system ensures perfect shredding and increases the load capacity
- Optimal accessibility for fast conversion from collecting to mulching function
- A special delivery chute prevents blockages due to material backup or full containers



Driving power in hp:



Hydraulic motor l/min:

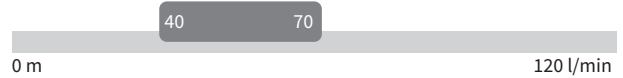

Working width in metres:

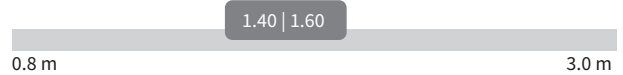

- A proven tool for any task, the carbide M-shackle flail
- Forward-mounted insect rescuer optional



OUR VIDEO TIP

The MU-Collect Vario flail mower
See it in action on YouTube.
Just scan the QR code!



A FLAIL MOWER FOR ALL SEASONS MULCHING - SCARIFYING - COLLECTING



Both mechanical and hydraulic drive are possible, optimised for the vehicle.

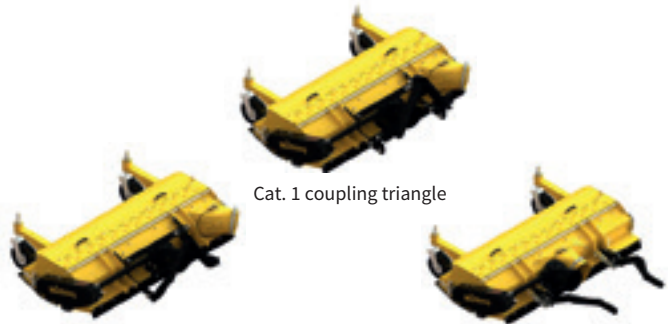

Cat. 0 coupling triangle

Cat. 1 coupling triangle

Mounting console for support arms

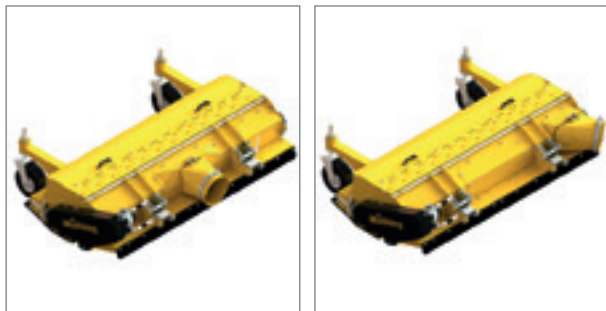

Vehicle-specific discharge centrally (Collect 140/160) or to the right (Collect 160) in the direction of travel.



MU-Vario® for an optimised intake and housing form and steplessly adjustable shredding rates, ensuring ideal mulch quality and shredding performance.

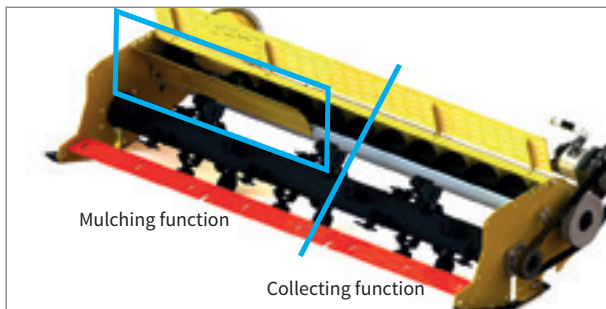

Mulching function

Collecting function

The discharge plate is used to switch from the collecting to the mulching function.



Front support wheels installed as standard facilitate handling and improve ground following. They are vertically adjustable and swivel through 360°. A forward-mounted insect rescuer is available optionally.

Technical Specifications

MU-Collect Vario MU-Collect Vario Hydro	140	160
Working width (cm)	140	160
Total width (cm)	162	182
Max. tractor hp 2000 rpm	40	40
Weight (kg)	223	244
Number of carbide M-shackle flails	24	28
Oil volume, l/min	35-70	45-70



Scarifying blades cut up and aerate the matted layer in the root crown area to improve the soil structure in the long term (optional). The scarified material is collected directly by the MU-Collect.

MU-FM/S

PROFESSIONAL SIDE FLAIL MOWER FOR MUNICIPAL TRACTORS

- Full performance capability in a compact size
- Easy to handle, even around obstacles
- A proven tool for any task, the carbide M-shackle flail
- Just two double-acting control devices allow you to control the machine
- Mulching is possible both behind and to the side of the tractor thanks to the extreme adjustment range of 112 cm
- Hardox™ wear runners as standard



Driving power in hp:



Working width in metres:



OPTIMAL RESULT: ALONGSIDE AND BEHIND THE TRACTOR



Secure transport lock for on-road driving or when transporting the tractor/equipment combination on a passenger car trailer.



A large adjustment range makes it possible to work both behind and alongside the tractor. Narrow access tracks and side strips can be mulched just as easily.



The patented mechanical collision protection device responds reliably and returns automatically to the working position.



V-belt tension is always visible: V-belt protection with inspection opening.

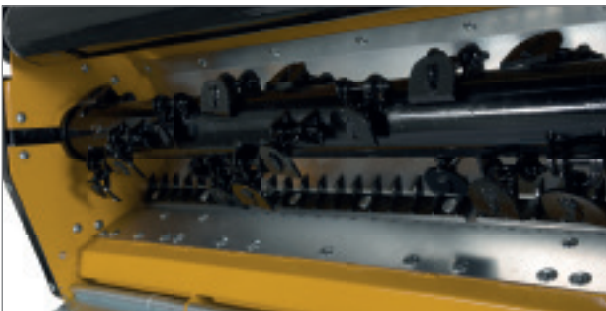

Wear insert for rough day-to-day usage by service providers and municipal authorities (optional).

Technical Specifications

MU-FM/S	120	140	160
Working width (cm)	120	140	160
Max. tractor hp	45	45	45
Weight (kg)	340	353	370
Number of carbide M-shackle flails	20	24	28
Minimum tractor weight kg	1.000	1.100	1.200

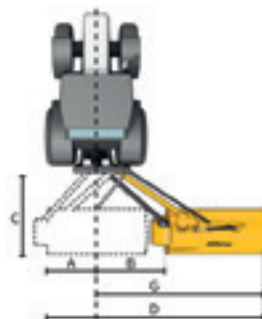

	120	140	160
A	29	29	29
B	83	83	83
C	160	160	160
D	232	252	272
E	90	90	90
F	60	60	60
G	203	223	243



Working/adjustment ranges (cm)

- A Adjustment range to left approx.
- B Adjustment range to right approx.
- C Transport length to rear approx.
- D Total working range incl. equipment width approx.
- G External width

Working ranges (°)

- E Angular range upwards
- F Angular range downwards

MU-E Vario

AT HOME ON ANY TERRAIN

- Multiple use from fine ornamental lawns through to rough growth
- MU-Vario® system and Hardox™ wear runners as standard
- A proven tool for any task, the carbide M-shackle flail
- For use in intensive applications: Optimal material draw and uniform cutting pattern thanks to the short-cut flap (optional)
- Stepless adjustment of cutting height from 15-70 mm with just one tool
- Mounting options for any vehicle size: Cat. 0 triangle, Cat. 1 three-point and mounts for carrier vehicles
- Mechanical side shift as standard
- Forward-mounted insect rescuer optional



Driving power in hp:



Working width in metres:

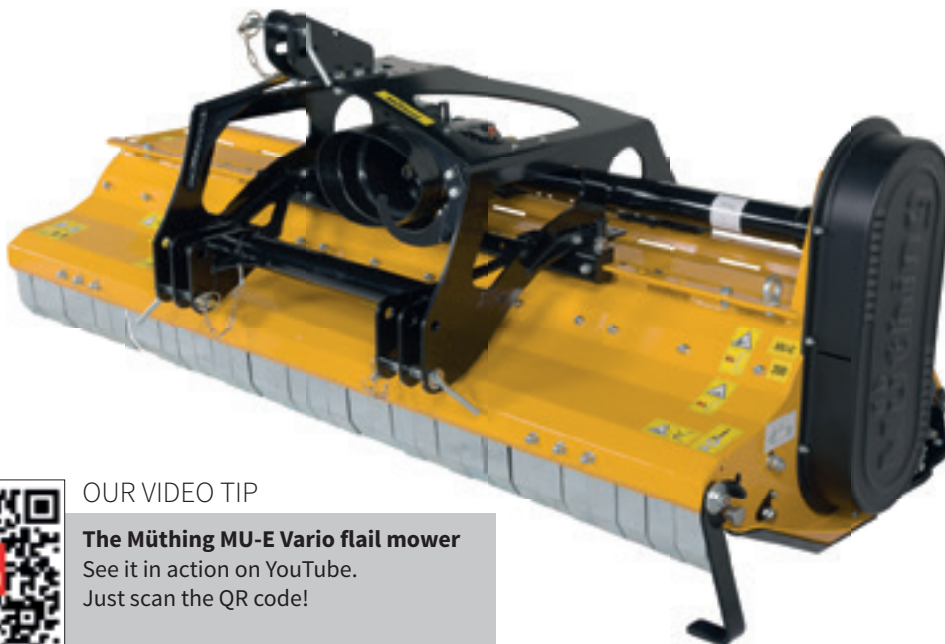

OUR VIDEO TIP

The Mühling MU-E Vario flail mower
See it in action on YouTube.
Just scan the QR code!



ECONOMY AND EFFICIENCY IN LANDSCAPING

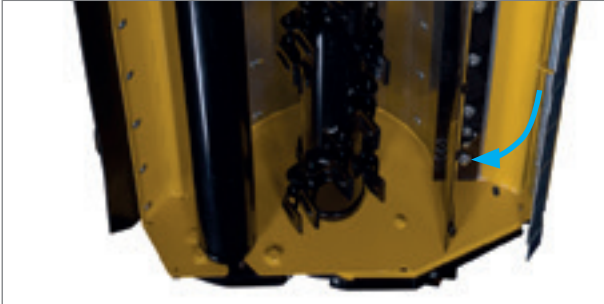

The short-cut flap can be quickly folded down manually to ensure a clean cutting pattern.



MU-Vario® for an optimised intake and housing form and steplessly adjustable shredding rates. The result is ideal mulch quality and shredding performance.

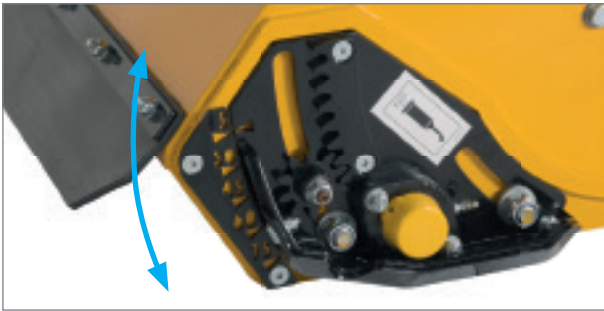

Quick adjustment of cutting height with just one tool: Release the threaded connection / adjust the cutting height / tighten the threaded connection.



Hydraulic side shift: Mulching at an offset to the side of the tractor provides flexibility for trees, access zones or other obstacles (optional).



Possible power take-off shaft speeds:

- With rear mounting 540 or 1000 rpm
- With front mounting 1000 or 2000 rpm



Internal rotor bearing to protect against foreign objects and collisions. The special anti-wrapping device prevents long-fibred materials from "wrapping around".

Technical Specifications

MU-E Vario	120	140	160	180	200
Working width (cm)	120	140	160	180	200
Total width (cm)	135	155	175	195	215
Max. tractor hp 540/1000 rpm	50/60	50/60	50/60	50/60	50/60
Weight (kg)	280	300	330	360	390
Number of carbide M-shackle flails	20	24	28	32	36



The forward-mounted insect rescuer scares away small organisms such as flying insects, dragonflies and bees that are sitting on raised blades of grass.

MU-E HYDRO VARIO + MU-CONNECT 200

MU-E HYDRO VARIO WITH MU-CONNECT LOADER MOUNT

- For mounting on small to medium-sized yard and wheel loaders up to 90 l/min
- Play-free and quick coupling thanks to the custom-fit vehicle-specific mounting parts
- MU-CONNECT 200 ensures both exact cutting height guidance and the required clearance for any terrain
- Scuffing during steering manoeuvres is prevented by the low weight loading of the support roller and the ground is thus protected
- Screw-type Hardox™ wear runners as standard



Hydraulic motor l/min:



Working width in metres:



ECONOMY AND EFFICIENCY ON WHEEL LOADERS



Adapter plates are also available for the following models: Ladog, Multicar Tremo, Multicar Fumo, Hansa, Holder Muvo and Manitou wheel loader.



Vehicle-specific mounting parts: The low coupling point ensures a good overview thanks to the low linkage position. Good accessibility to the hydraulic connections.



Virtual pulling point - A Müthing patent: The flail mower is pulled with low rolling resistance instead of pushed and thus follows every ground contour perfectly.



Clever following when cornering as the machine follows the steering radius.



The correct work position can be determined conveniently using a height indicator visible from the cab.

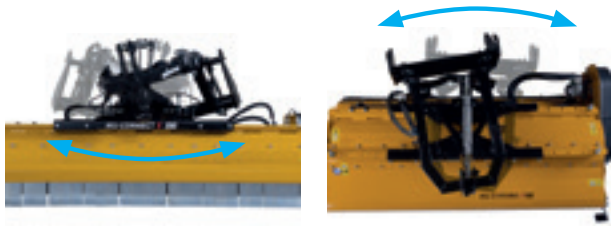

On uneven surfaces, generous swinging and steering movements ensure optimal ground following.

Technical Specifications

MU-E Hydro Vario	140	160	180	200
Working width (cm)	140	160	180	200
Total width (cm)	155	175	195	215
Weight (kg)	310	340	370	380
Number of carbide M-shackle flails	24	28	32	36
Oil volume, l/min	50-90	50-90	50-90	50-90

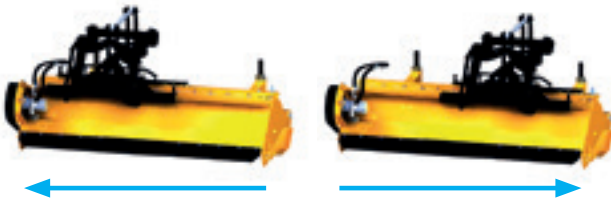

Hydraulic side shift with 26 cm adjustment travel. Mulching at an offset to the side of the tractor provides flexibility for trees, access zones or other obstacles (optional). Mechanical side shift is equipped as standard.

MU-E/F TRAIL VARIO

HIGH SURFACE OUTPUT, FLEXIBILITY AND SIMPLE HANDLING

- Maximum working width in the area, manageable transport position with 2.5 m transport width and total height of 3 m
- MU-Vario® system and Hardox™ wear runners as standard
- A proven tool for any task, the carbide M-shackle flail
- For use in intensive applications: Optimal material draw and uniform cutting pattern thanks to the short-cut flap (optional)
- The efficient drivetrain combines durability with maximum performance and optimal efficiency
- Perfect ground following due to the MU-SOFA® weight transfer system
- User-friendly handling with just one operation needed for turning



Driving power in hp:



Working width in metres:

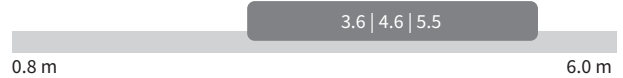

EFFICIENCY OVER A LARGE AREA



Efficient powertrain, compact design for high driving power.



For simple operation, folding and headland rams are designed separately.



The trailed suspension of the two side mulchers makes possible a fluid contour outline with consistent cutting height.



Tidy: The on-board hydraulics with the MU-SOFA® weight transfer system.



Small transport dimensions and a chassis design with wide tyres guarantee a smooth ride that protects the soil.



In the event of a problem, the mechanical collision protection device swivels the mulcher out of the collision zone effectively.

Technical Specifications

	MU-E/F Trail Vario	360	460	560
Working width (cm)		360	460	560
Total width (cm)		210	230	240
Max. tractor hp 540/1000 rpm		130/180		
Weight (kg); pulled		1.950	2.150	2.350
Weight (kg); separate		1280 (MU-E/F 360 Vario) 1380 (MU-E/F 460 Vario) + 390 (MU-E 200 Vario)		
Number of carbide M-shackle flails; drawn		68	88	108
Number of carbide M-shackle flails; separated		40 (MU-E/F 360 Vario) 56 (MU-E/F 460 Vario) + 36 (MU-E 200 Vario)		

MU-E/S

THE SIDE FLAIL MOWER FOR EVERY APPLICATION

- The MU-E/S flail mower can be operated at the front or at the rear
- A proven tool for any task, the carbide M-shackle flail
- The sturdy tubular frame design allows compact mounting close to the tractor
- A mechanical collision protection device in the headstock protects the housing and tubular frame from damage
- Just two double-acting control devices allow you to control the machine
- Folds up for space-saving storage



Driving power in hp:



Working width in metres:



EFFICIENCY ACROSS THE BOARD



A sturdily designed front/rear headstock allows flexible usage in front of or behind the tractor/carrier vehicle (optional).



Wear insert for rough day-to-day usage by service providers and municipal authorities (optional).



Short design for a centre of gravity close to the tractor.



The hydraulic side shift functionality equipped as standard allows safe working on ditches and obstacles with an adjustment range of 50 cm.



The mechanical collision protection device protects the mulcher effectively against collision damage if the worst comes to the worst.



Hardox™ wear runners as standard for long service life.



A clever design allows the MU-E/S mulcher to be folded up for space-saving storage.

Technical Specifications

MU-E/S	120	140	160
Working width (cm)	120	140	160
Max. tractor hp	60	60	60
Weight (kg)	497	520	543
Number of carbide M-shackle flails	20	24	28

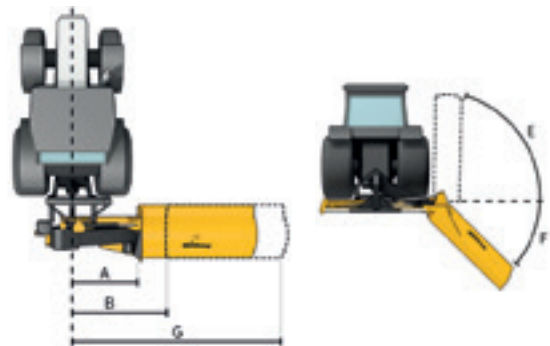

	120	140	160
A	86	86	86
B	136	136	136
G	256	276	296
E	90	90	90
F	60	60	60

Working/adjustment ranges (cm)

- A** Side mounting to right approx.
- B** Adjustment range to right approx.
- G** External width to right approx.

Working ranges (°)

- E** Angular range upwards
- F** Angular range downwards

MU-H Vario

UNLIMITED POSSIBILITIES FOR PROFESSIONAL LANDSCAPING

- Sturdy mulcher for any type of terrain. Lightweight tractors and carrier vehicles are also possible, especially in Alpine settings
- MU-Vario® system available
- Use the MU-H Vario as it suits you, with front or rear mounting on your tractor or carrier vehicle (optional)
- Customised working width for your application



Driving power in hp:



Working width in metres:



A LANDSCAPING ALL-ROUNDER



Use with front or rear mounting possible (optional).



A special Cat. 1 3-point trestle is available for carrier vehicles.



MU-Vario® for an optimised intake and housing form and steplessly adjustable shredding rates. The result is ideal mulch quality and shredding performance.



Hydraulic side shift: Mulching at an offset to the side of the tractor provides flexibility for trees, access zones or other obstacles (optional).

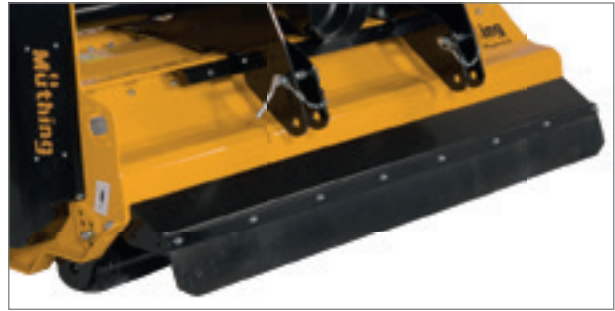

The dust protection system for carrier vehicles prevents obstruction of the field of view and excessive soiling of low-lying intake points due to the production of dust.



PTO shaft speeds of 540 or 1000 rpm are possible.



Insect rescuer: A specially designed, hydraulically folding bracket with integrated angled tines frightens away insects and small organisms from the front of the flail mower and causes them to flee. (optional for working widths of 1,60 m and 2.20 m)

Technical Specifications

MU-H Vario	120	140	150	160	180	200	220
Working width (cm)	120	140	150	160	180	200	220
Total width (cm)	137	157	167	177	197	217	237
Max. tractor hp 540/1000 rpm	75/90	75/90	75/90-	75/90	75/90	75/90	75/90
Weight (kg)	380	465	480	500	535	555	635
Number of M-DuraX hammer flails	10	12	12	14	16	16	18

MU-H/S Vario

THE MID-RANGE LANDSCAPING FLAIL MOWER

- The compact design of this unit simplifies mulching between obstacles such as trees
- MU-Vario® system available
- With a housing height of just 44 cm, it is easy to mulch the area underneath fences
- Whether you are working in ditches or on embankments, the MU-H/S Vario allows you to follow every contour
- Just two double-acting control devices allow you to control the machine
- Mulch both behind and alongside the tractor
- Screw-type Hardox™ wear runners as standard



Driving power in hp:



Working width in metres:



A LANDSCAPING ALL-ROUNDER, ALSO WITH SIDE ARM CONFIGURATION



The patented mechanical collision protection device responds reliably and returns automatically to the working position.



MU-Vario® for an optimised intake and housing form and steplessly adjustable shredding rates. The result is ideal mulch quality and shredding performance.



A large adjustment range makes it possible to work both behind and alongside the tractor. Narrow access tracks and side strips can be mulched just as easily.



Plenty of space for mounting on the tractor and the swivelling PTO shaft.



Rotating warning signs with LED lighting equipment and lighting equipment support, with sturdy mounting and without moving parts

Technical Specifications

MU-H/S Vario	140	160	180	200
Working width (cm)	140	160	180	200
Max. tractor hp	90	90	90	90
Weight (kg)	650	660	690	720
Number of M-DuraX hammer flails	12	14	16	16
Minimum tractor weight (kg)	1.800	2.000	2.200	2.400

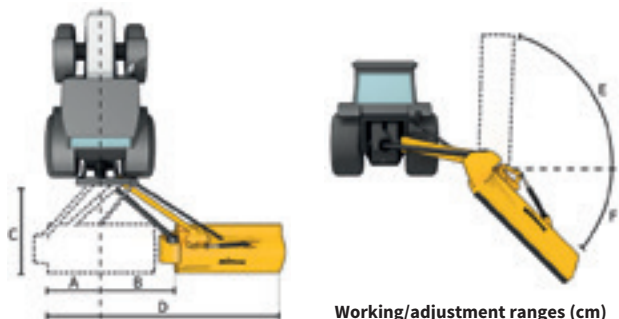

Working/adjustment ranges (cm)

	140	160	180	200
A	55	55	55	55
B	100	100	100	100
C	225	225	225	225
D	295	315	335	355
E	90	90	90	90
F	60	60	60	60

A Adjustment range to left approx.
B Adjustment range to right approx.
C Transport length to rear approx.
D Total working range incl. equipment width approx.

Working ranges (°)

E Angular range upwards
F Angular range downwards

MU-L Vario

UNIVERSAL FLAIL MOWER FOR ROUGH DAY-TO-DAY USE IN MUNICIPAL APPLICATIONS

- Multiple use in parks, non-intensively maintained green spaces and roadside greenery
- MU-Vario® system available
- Use the MU-L Vario as it suits you, with front or rear mounting on your tractor (optional)
- Customised working width for your application
- Crop discharge in front of the large support roller is also possible optionally
- Long service life thanks to the internal Starinth® support roller bearing
- Screw-type Hardox™ wear runners with separating effect as standard



Driving power in hp:



Working width in metres:



HIGHLY VERSATILE



Use with front or rear mounting possible (optional).



MU-Vario® for an optimised intake and housing form and steplessly adjustable shredding rates. The result is ideal mulch quality and shredding performance.



Hydraulic side shift: Mulching at an offset to the side of the tractor provides flexibility for trees, access zones or other obstacles (optional).



With two sturdy adapter plates, crop discharge in front of the support roller is also possible (optional).



Starinth® rear roller bearing.



Power take-off shaft speeds of 540 or 1000 rpm are possible on the MU-L Vario 180-250.

Technical Specifications

MU-L Vario	180	200	220	250	280
Working width (cm)	180	200	220	250	280
Total width (cm)	197	217	237	267	297
Max. tractor hp 540/1000 rpm	100/130	100/130	100/130	100/130	--/130
Weight (kg)	640	670	740	790	885
Number of M-DuraX hammer flails	16	16	18	22	24

MU-L/S Vario

STRONG PERFORMANCE ON EMBANKMENTS, SIDE STRIPS AND ON THE FLAT

- Full flexibility with a large working width
- MU-Vario® system available
- Whether you are working in ditches or on embankments, the MU-L/S Vario allows you to follow every contour
- Just two double-acting control devices allow you to control the machine
- Long service life thanks to the internal Starinth® rear roller bearing system
- Heavy duty rear/side arm
- Mulch both behind and alongside the tractor
- Screw-type Hardox™ wear runners with separating effect as standard



Driving power in hp:



Working width in metres:



EXTRA SURFACE OUTPUT FOR ANY APPLICATION



Plenty of space for mounting on the tractor and the swivelling PTO shaft.



MU-Vario® for an optimised intake and housing form and steplessly adjustable shredding rates. The result is ideal mulch quality and shredding performance.



A large swivel range makes it possible to work both behind and alongside the tractor. Narrow access tracks and field edges can be mulched just as easily.



The patented mechanical collision protection device responds reliably and returns automatically to the work position.



Starinth® rear roller bearing.



Rotating warning signs with lighting equipment and lighting equipment support with sturdy mounting and without moving parts

Technical Specifications

MU-L/S Vario	200	220	250
Working width (cm)	200	220	250
Max. tractor hp	130	130	130
Weight (kg)	910	930	950
Number of M-DuraX hammer flails	16	18	22
Minimum tractor weight (kg)	2.800	3.200	3.500

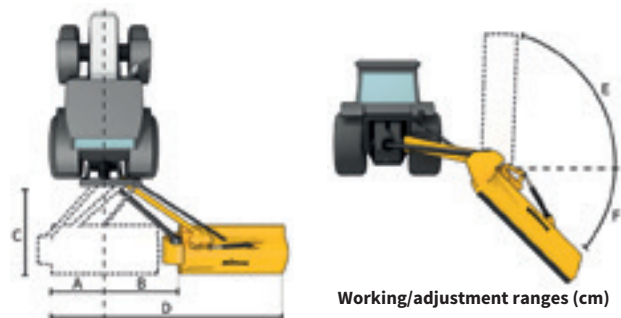

Working/adjustment ranges (cm)

	200	220	250
A	70	70	70
B	105	105	105
C	250	250	250
D	375	395	425
E	90	90	90
F	60	60	60

A Adjustment range to left approx.
 B Adjustment range to right approx.
 C Transport length to rear approx.
 D Total working range incl. equipment width approx.

Working ranges (°)

E Angular range upwards
 F Angular range downwards

SERVICE

RELIABILITY AS STANDARD

The foundation of durability

Even in the early design phase of a Mühling flail mower, reliability is one of the most important development criteria for us.

Irrespective of whether the equipment is being used to manage seasonal peaks, for tough day-to-day tasks or for intensive and continuous operation. We want you to be able to depend on your Mühling flail mower - right from the beginning.

NOW WITH NEW ALLOY!

The new M-DuraX mulching tool impresses with optimal ergonomic features combined with high-strength boron-alloyed and tempered steel for a perfect mulching result and up to 50% longer service life.

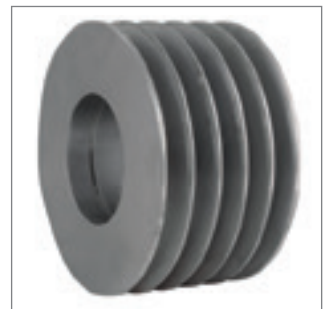
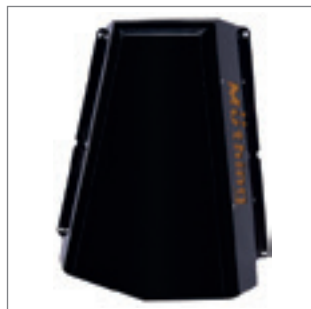

Fast assistance

This means helping you without complication and within the shortest period of time - exactly when you really need it. To ensure that your Mühling flail mower is back up and running again quickly.

Genuine spare parts

Mühling spare parts are designed to uphold our quality promise. Our selection of outstanding components ensures a long service life.

High-quality spare parts are available for every flail mower. And they will be for a very long time after you have decided to purchase a Mühling flail mower.

You can count on us. With Mühling spare parts, we will quickly provide a long-lasting solution to your emergency.

WHEN THE WORK CANNOT WAIT



CORE EXPERTISE: SMOOTH-RUNNING ROTORS

The centrepiece of every flail mower is the rotor with its tools. The smooth running characteristics of a rotor have a strong influence on its durability, uniformity of work results and continuous power demand. Every Müthing rotor is designed to maintain these characteristics for a long time, even under heavy duty usage.

But if the worst comes to the worst and your rotor is damaged by foreign object, an imbalance can occur. With our in-house balancing machine, our service team can help you quickly and without complication.

Our service for you:



In-house balancing machine



Experienced experts



Genuine Müthing tools sorted into 3 weight stages (20 grams each)

TECHNICAL DATA

	MU-B	MU-C MU-C Hydro	MU-C/S	MU-FM MU-FM Hydro	MU-Ecotop	MU-Collect Vario MU-Collect Vario Hydro	MU-FM/S	MU-E Vario
Dimensions and weights								
Working width (cm)	80 100 120 140	80 100 120 140 160 120 140 160	100 120	120 140 160	140 160	140 160	120 140 160	120 140 160 180 200
Transport width (cm)	97 117 137 157	104 124 144 164 184 144 164 184	158 178	145 165 185	165 185	162 182	n/a	135 155 175 195 215
Weight (kg)	120 137 154 171	Front: -- 145 151 159 175 185 200 215 Rear: 154 169 185 200 215 138 146 154	208 225	206 229 252 201 217 232	236 283	223 244	340 353 370	280 300 330 360 390
Driving power								
Power demand* from -to (HP)	15 - 25	15 - 35	20 - 35	20 - 40	20 - 40	20 - 40	30 - 45	25 - 50/60
Power demand of hydraulic motor from-to (l/min)	-	35 - 55	-	35 - 70	-	40 - 70	-	-
PTO shaft speed* (rpm)	n/a	540 / 1.000 / 2.000 n/a	540	2.200 n/a	2.200	1.000 / 2.000 n/a	540	1000 / 2000 Front 540 / 1000 Rear
Freewheel	Integrated overrun brake	■	■	■	■	■	■	■
Number of V-belts	2	2	2	2	2	2	2	2
Mounting								
Front	■	□	-	■	■	■	-	□
Rear	-	□	■	-	-	-	■	□
Front-Rear	-	-	-	-	-	-	-	-
Quick-coupling triangle for front mounting	-	□ Cat. 0 □ Cat. 1	-	□ Cat. 0 / 1N	□ Cat. 0 / 1N	□ Cat. 0 / 1N	-	□ Cat. 0 / 1N
Mechanical side shift	-	-	-	-	-	-	-	20 20 25 25 25
Hydraulic side shift	-	□	-	□	-	-	■	□
Control devices	-	-	min. 1 DA	min. 1 DA	-	-	min. 2 DA	min. 1 DA
Working/adjustment ranges								
A: Adjustment range to left / A: Side mounting to right	-	-	-	-	-	-	29 29 29	n/a
B: Adjustment range to right	-	-	-	-	-	-	83 83 83	n/a
C: Transport length to rear / C: Total width to right	-	-	-	-	-	-	160 160 160	n/a
D: Total working range incl. equipment width	-	-	-	-	-	-	232 252 272	n/a
E: Angular range upwards (°)	-	-	90	-	-	-	90	-
F: Angular range downwards (°)	-	-	45	-	-	-	60	-
Rotor								
Diameter (cm)	11	11	11	11	11	11	11	13
Effective diameter (cm)	31	31	31	31	31	31	31	36
Number of tools	12 16 20 24	12 16 20 24 28 20 24 28	16 20	20 24 28	24 28	24 28	20 24 28	20 24 28 32 36
M-DuraX hammer flails	-	-	-	-	-	-	-	-
M-shackle flail	-	-	-	-	-	-	-	-
Carbide M-shackle flail	■	■	■	■	-	■	■	■
M-scoop blade	□	□	□	□	-	□	□	-
Y-blade	□	-	-	-	■	-	-	-
Scarifying blade	-	-	-	-	-	□	-	-
Depth control								
Support roller	■	■	■	■	-	■	■	■
Front/rear position	Fixed	Fixed	Fixed	Fixed	Fixed	Fixed	Fixed	Fixed
Diameter (cm)	12	12	10	12	12	10	12	12
Support wheels	-	□ Only with front attachment	-	■ Front □ Rear	■	■	-	□
Housing								
Wear insert	□	□	-	□	□	■	□	□
Hardox™ wear runners	■	■	■	■	■	■	■	■
Vario cutting bar	-	-	-	-	-	■	-	■
Short-cut flap	-	-	-	-	-	□	-	□
Short chopping bar (shark fin)	■	■	■	■	■	■	■	■
Second short chopping bar	-	□	-	□	□	-	-	□
Optional equipment								
Front shock-absorbing spring assembly	-	-	-	-	-	-	-	-
MU-SOFA® weight transfer system	-	□	-	□	□	□	-	□
Warning signs with LED lighting equipment	-	-	-	-	-	-	-	□
Operating hours counter	-	-	-	-	-	□	□	□

	MU-E Hydro + MU-Connect	MU-E/F Trail Vario	MU-E/S	MU-H Vario	MU-H/S Vario	MU-L Vario	MU-L/S Vario
Dimensions and weights							
Working width (cm)	140 160 180 200	360 460 560	120 140 160	120 140 150 160 180 200 220	140 160 180 200	180 200 220 250 280	200 220 250
Transport width (cm)	155 175 195 215	210 230 240	n/a	137 157 167 177 197 217 237	n/a	197 217 237 267 297	n/a
Weight (kg)	280 310 340 370	1950 2150 2350	497 520 543	380 465 480 500 535 555 635	650 660 690 720	640 670 740 790 885	910 930 950
Driving power							
Power demand* from -to (HP)	-	60 70 80 - 130 / 180	30 - 60	35 - 75 / 90	55 - 90	45 - 100 / 130	75 - 130
Power demand of hydraulic motor from-to (l/min)	50 - 90	-	-	-	-	-	-
PTO shaft speed* (rpm)	n/a	540 / 1.000	540 / 1.000	540 / 1.000	540	540 / 1.000	540
Freewheel							
Number of V-belts	2	2 (individual flail mower)	3	3	4	4	4
Mounting							
Front	■	-	□	□	-	□	-
Rear	-	■	■	■	Cat. 2	□	Cat. 2
Front-Rear	-	-	□	Cat. 1 + 2	-	Cat. 1 + 2	-
Quick-coupling triangle for front mounting	□ Cat. 0	-	-	-	-	-	-
Mechanical side shift	20 25 25 25	-	-	■	-	■	-
Hydraulic side shift	□	-	■	□	■	□	■
Control devices	min. 1 DA	min. 2 DA + 2 SA	min. 2 DA	min. 1 DA	min. 2 DA	min. 1 DA	min. 2 DA
Working/adjustment ranges							
A: Adjustment range to left / A: Side mounting to right	n/a	n/a	86 86 86	n/a	55 55 55 55	n/a	70 70 70
B: Adjustment range to right	n/a	n/a	136 136 136	n/a	100 100 100 100	n/a	105 105 105
C: Transport length to rear / C: Total width to right	n/a	n/a	256 276 296	n/a	225 225 295 315 335 355	n/a	250 250 250
D: Total working range incl. equipment width	n/a	n/a	n/a	n/a	n/a	n/a	375 395 425
E: Angular range upwards (°)	-	-	90	-	90	-	90
F: Angular range downwards (°)	-	-	60	-	60	-	60
Rotor							
Diameter (cm)	13	13 (individual flail mower)	11	14	14	16 16 16 16 18	16
Effective diameter (cm)	36	36 (individual flail mower)	42	40	40	42 42 42 42 44	42
Number of tools	24 28 32 36	68 88 108	20 24 28	10 12 12 14 16 16 18	12 14 16 16	16 16 18 22 24	16 18 22
M-DuraX hammer flails	-	-	-	■	■	■	■
M-shackle flail	-	-	-	□	□	□	□
Carbide M-shackle flail	■	■	■	-	-	-	-
M-scoop blade	-	-	-	-	-	-	-
Y-blade	-	-	-	-	-	-	-
Scarifying blade	-	-	-	-	-	-	-
Depth control							
Support roller	■	■	■	■	■	■	■
Front/rear position	Fixed	Fixed	Fixed	Fixed	Fixed	Adjustable	Adjustable
Diameter (cm)	12	12	12	14	14	19	19
Support wheels	-	-	-	-	-	-	-
Housing							
Wear insert	□	■	□	□	□	□	□
Hardox™ wear runners	■	■	■	■	■	■	■
Vario cutting bar	■	■	-	■	■	■	■
Short-cut flap	□	□	-	-	-	-	-
Short chopping bar (shark fin)	■	■	■	■	■	■	■
Second short chopping bar	□	□	□	□	□	□	□
Optional equipment							
Front shock-absorbing spring assembly	-	-	-	□	-	□	-
MU-SOFA® weight transfer system	□	■	-	□	-	□	-
Warning signs with LED lighting equipment	□	■	□	□	□	□	□
Operating hours counter	-	□	□	□	□	□	□

- Not available

■ Standard □ Optional

OPTIMAL MULCHING WITH MÜTHING



Müthing

Müthing GmbH & Co. KG Soest

Am Silberg 23
D-59494 Soest

Tel. +49 (0) 2921 96510
Fax + 49 (0) 2921 73080

soest@muething.com

Müthing GmbH & Co. KG Uffenheim

Am Brunnlein 2
D-97215 Uffenheim

Tel. +49 (0) 9842 98660
Fax + 49 (0) 9842 98667

uffenheim@muething.com

www.muething.com



Your Contact:

SIMON RICHARD LTD

Crown Tailrig • Bonchester Bridge • Hawick • TD9 8RA
Tel: 01450 860774 • Fax: 01450 860772
E-mail: simon@simon-richard.co.uk
www.simon-richard.co.uk